

FOVERAN COMMUNITY NEWSLETTER

December 2015

Issue 142

FORMARTINE CHRISTMAS TREES
Fiddesbeg Farm, Udny, Ellon, AB41 6QT

We sell the UK's favourite Nordmann Fir trees, famous for their glossy green colour and large soft needles, making it suitable for those with young children.

Choose your tree on our farm, or if you prefer, we can deliver it straight to your door!

£1 from each Christmas Tree will go to Cash For Kids to help support children within the local area.

Please call Magnus on 07774 893101 or our office on 01651 842487 for further information, prices or to reserve your perfect Christmas Tree.



Reliable
experienced
professional

*...everything you
want from your
local builder*

With 30 years experience,
you can trust us to help you
create your dream home

- New houses
- Extensions
- Concrete work
- Roofing & reslating
- All drainage & siteworks
- Septic tanks
- Insurance work carried out



Michael Duncan Builders Ltd

michaelduncanbuilders.co.uk

CALL TODAY FOR A FREE QUOTE

01358 789 562

Mob: (Mike) 07710 903 535 • (Keith) 07810 212 503 • Email: mike@michael-duncan.co.uk
Michael Duncan Builders Ltd, West Pitmillan Business Centre, Foveran, Ellon, AB41 6AL



Secretary report for November / December 2015 newsletter

If you want to place an advert in future editions of the newsletter which is published three times a year then please contact me on 01358 789761 or e mail g_cdouglas@hotmail.com

Foveran Community Council looks after the interest of the residents of Newburgh, Foveran, Udney Station and Cultercullen, and everything in between.

The newsletter can now be accessed after publication by anyone on

<https://foverannews.wordpress.com/electronic-news-letter/>

We act as a focal point where you can bring to our attention matters that may concern you. Elected councillors from Aberdeenshire Council normally also attend our meetings which are open to all.

Agendas for the meetings and minutes of the meetings are available on line at www.formartinecommunitycouncils.co.uk

A list of community councillors and scheduled meeting dates is on the back page.

This newsletter would not be possible without the support of the companies who advertise in it, so please consider them when thinking of making a purchase.

To the new residents of the Sinclair Park in Newburgh, and for others who have moved to the Community Council area, we welcome you to our community.

We wish to put on record our thanks to Anne Massie, and Martin Warrior both of whom have resigned from the community council.

Tommy Hart has joined the council, however at present Foveran is not represented on the Community Council and we urgently need someone to represent the residents of Foveran. If you are willing to represent Foveran, then please contact me.

Gallowhill Sports Hub continues to be successful and is available to all, not just the residents of Newburgh, with football, tennis, netball available, as is the hire of the pavilion for private and community meetings

Thanks to the efforts of the Nicer Newburgh group, Newburgh was awarded first prize from Formartine in Bloom 2015 in the medium Community category.

The floral displays throughout the village and to the North beside the Ythan are beautiful.

The new boardwalk from the beach car park to the top of the dunes is requiring remedial work to the edges. Aberdeenshire Council are aware of this and will be addressing the situation.

The community were unable to provide an economic and sustainable option to replace the Spalding Bridge in Newburgh, therefore the bridge decking is due for removal before the end of the year, with the concrete foundations being removed Spring 2016.

The old tennis pavilion in Newburgh, is still scheduled for demolition but is taking longer than anticipated.

There are plans to make changes to the traffic arrangements to Knockhall Road, and the Community Council has objected to the proposed changes, which would funnel even more traffic on to Main Street, however our objections were over-ruled.

There is the opportunity for Newburgh residents to object individually. Details are on the notices on the lampposts at Knockhall Road/ Main Street junction.

It is hoped that the Post Office will provide postal facilities in Newburgh very shortly with a mobile van.

If anyone has any interest in being involved in setting up a Post Office facility in Newburgh, please contact me, and I will put you in touch with the Post Office personnel.

The group running Newburgh Village Hall urgently need help to continue to run this facility which is extensively used. If you are a member of a group which regularly uses the hall then we need your help. Please contact Rose Moroney on 01358 780353

We have been successful in obtaining funding for Foveran under the tidy village scheme, however as previously mentioned, we need someone to represent the village to administer this, typically for grass cutting or litter picking.

Congratulations to the residents of Cultercullen who clubbed together to purchase land in the village that will become a community park

We are working on modifying the boundary between Foveran and Udney Community Councils in the Udney Station area as at present the boundary passes through the houses in Chestnut Walk.

Finally with Christmas and New Year approaching fast we take this opportunity of wishing you all a merry Christmas and Happy New Year

Glen Douglas

**Corner
a
f
é**



Newburgh Church Hall
10-12noon on
Thursdays - all welcome

*The Festive Coffee Morning will
be held on 17th December.
The café will then be closed for
4 weeks and will re-open on
21st January 2016.*

**The Ice Cream
& Coffee Pot**

36 Market Street
Ellon
Aberdeenshire
AB41 9JD

Tel: 01358 720381



LIVED-IN
nest nurture live

Painted furniture, soft furnishings,
home accessories and gifts



Neil Ross Square : 27 Bridge Street : Ellon : AB41 9AA
www.lived-inhome.co.uk
Open Wed-Sat 10-5

LOKAL-LOKS
EMERGENCY LOCKSMITH
UPVC doors & windows a speciality
Mobile 07703 472 390
132a Main Street, Newburgh.
Aberdeenshire. AB41 6BN

Rocco



Hair Design by Lindsay Norrie



Find us right beside
The Store and Coffee Shop
Foveran, Ellon AB41 6AY

*Lindsay and Bentley would like to wish you all a
Very Merry Christmas and a Happy and
Prosperous New Year 2016*



*Styling for Ladies, Gents and
Children at*

Rocco

*Do pop in anytime to say hello or make your
appointment on:*

01358 789793

CITY REGION DEAL

Councillor Richard Thomson

I had the pleasure in October of helping to lead a delegation to the Scottish Parliament, making the case for the Aberdeen City Region Deal.

The “deal” is one which – if successful – would involve both the Scottish and UK Governments working together with Aberdeenshire Council, Aberdeen City Council and a range of public and private sector partners in order to deliver a potential £2.9 billion package of investment, incentives and permissions for the North East.

Covering themes of innovation, internationalisation, connectivity and housing, the aim of the projects making up the deal is to anchor the expertise which we have in our energy sector into the North East for the long-term, so helping to maximise oil and gas recovery from the North Sea. At the same time, it will seek to diversify the region’s economic base and increase our exports, while tackling the constraints we face in terms of poor infrastructure and a shortage of housing.

If we are successful, it has the potential to be transformative for the economic future of Aberdeen City and Shire. We believe that the cross-sector, cross-party approach which has been adopted has only strengthened our case. The final bid will be submitted by the end of the year, but for now, you can find out more by visiting www.abzdeal.com or by following the #ABZ deal hashtag on twitter.

Budget Preparation

November will see Aberdeenshire Councillors meeting in order to begin the budget setting process for the financial year ahead.

Traditionally, local authorities set their budgets in February and that will remain the case in Aberdeenshire as well. However, what will mark out this time as being different is that by setting out our respective ambitions at an earlier stage, it should be possible to have greater public consultation and improved working between the various political groupings within the council.

In previous years, the actual budget day in council chambers across the country has seen broad agreement over 95% of how the budget should be allocated, with a great deal of sound and fury over differences in how to approach the remaining 5%. As the proposals for this are only ever revealed once the budget debate has actually started,

good and sensible proposals have often been thrown out for no good reason other than they were not the proposals of the council administration.

By starting the process earlier, we hope to give all councillors a chance to properly consider alternative proposals and to see whether there is common ground. As such, it is a chance for Aberdeenshire to do things differently, and to give all sides of chamber as well as the voters in Aberdeenshire an opportunity to contribute towards shaping the budget proposals which are passed.

It's a bold step, but hopefully it will become an approach which becomes second nature to us in the future no matter where we sit politically in the chamber.

GUITAR LESSONS

Classical and other styles

Newburgh based

Tel: 01358 789439

Mob: 07814912374

ALAN PENNY Ltd.

**Plumbing & Heating
Engineer**

**West Pitmillan
Foveran
Ellon AB41 6AL**

**Tel: 01358 723145
Mobile: 07710 873 276**

Nicer Newburgh Gardening Group

Formartine *in Bloom* 2015



Winner Newburgh

Category: Medium Community

Sponsored by



Celebrations
- OF TURRIFF -



Rambo's Tyre Services*

JRD
EQUIPMENT

formartine
partnership

Aberdeenshire
COUNCIL 

We hope all residents and visitors enjoyed the colourful displays of summer bedding in the various tubs and plantings throughout the village.

These are now being replaced with plants to provide colour during the winter and spring months. These are mainly polyanthus, although in the village hall corner, it is wallflower, and in Udney Arms planter and Links it is Bellis Perennis. Large daisies in other words, all very bright and cheerful.

Newburgh has this year won the medium communities class of Formartine in Bloom competition, and received a certificate and a cheque for 200 pounds, which has been added to group funds.

This is the third year of entering. In 2013, 1 year after the formation of the group, Newburgh was runner up, but in 2014 we dropped back in the face of stiff competition to be highly commended. The competition does not just look at floral displays, but also cleanliness, tidiness, community involvement and recycling. Prior to 2015, Pitmedden had won the medium communities class seven times in a row.

I am sure you can understand that all in the group are very proud of this achievement. The group have received 1000 crocus corms requested from Aberdeenshire Council Landscaping Services, which will be planted on the embankment on School

Road in front of the school field to additionally enhance the West entrance to the village.

Quite a lot of work has taken place recently as part of the ongoing enhancement of the South entrance to the village, whilst at the North entrance the planting is complete apart from the inevitable `tweaking.` Group members were still getting comments on how colourful it was, even in late October. On the Links play area and garden, it is hoped to continue the upgrade by removing some of the old weed infested heathers and replace them with scented roses.

We are a small group, although we have had a few more people join us this year. If you would like to join us, or would like to know more then please get in touch, contact Graham 01358 789024 or myself 01358 789527 or contact us at nicernewburgh@hotmail.co.uk

Agnes Kinloch

Farm Shop - Butchery - Coffee Shop

Aberdeen Angus Beef - Homebred Lamb

Pitcaple Pork - Aberdeenshire Chicken

Locally Sourced Vegetables - Scottish Artisan Products

Gourmet Hampers - Chef Prepared Meals

Lunches - Italian Aroma Coffee - Take Aways - Events



Open 7 days a week

10am—5pm

TheStore

The Store, Foveran, Newburgh, Ellon,
Aberdeenshire, AB41 6AY

Tel 01358 788083 Fax 01358 788199

www.thestorecompany.co.uk





Gala News

The new committee has been formed and we are all working hard to make next year's event even better than last year's overwhelming success. We would welcome any ideas or suggestions as to how we can improve our gala.

The gala date for your diaries is 21/5/2016.

What would you like to see at your gala?

We will be running several fund raising events leading up to the gala. Any suggestions or volunteers to help will be most welcome.

Our first event takes place on Sunday 29th November at 4pm. The Xmas tree lights will be switched on and we will be singing carols around the tree. Newburgh Mathers School Choir will lead the singing. Children of the village of all ages are very welcome to join in the singing. Of course adults are welcome as well!

After all your hard work singing there will be a welcome bowl of soup and pudding served in the public hall. We look forward to welcoming everyone to our village event. Do you want to get fit?

Why not train for the Newburgh Beach Bash?

This is our own village 10kms event. The gala will be supporting this event and the route takes you through the wonderful scenery we have on our doorstep.

The date for this event is 26th March 2016.

Remember you can also check out events on facebook or on our website www.newburghgala.com

Pat Smith
apatmsmith@gmail.com

Important dates for your diary

Sunday 29th November

Christmas Tree Lights switch on followed by
hot soup and pudding
4pm - Holyrood Church
Adults £5 Children £2.50

Food this year has been generously donated
by The Newburgh Inn.

Saturday 26th March 2016

We are delighted to announce that we are
again supporting the Newburgh Beach Bash
and will be providing
hot soup, tea & coffee with delicious
homebakes

Saturday 21st May 2016

Gala Day!

Please follow us on facebook or
checkout our website for regular updates
www.newburghgala.com

North East Open Studios 2015

Jane Bradford



Newburgh Mathers School Art Club visiting our NEOS exhibition

In September my dad (George Strachan) and I took part in North East Open Studios (NEOS). NEOS is a yearly event where artists and craftspeople from across the North East show their work in studios and various other venues over a period of 10 days. This year 221 exhibitors took part in the event.

Our exhibition of local land and seascape paintings took place in the summerhouse at the bottom of my garden in Newburgh. The exhibition was over 10 days from Sat 12th – Mon 21st September, and during that time we were surprised and delighted to have over 250 visitors to view our work. Visitors were a good mix of locals who had seen the exhibition advertised in the neighbourhood and people from further afar who were following a trail of NEOS exhibitors.

My work is mainly concentrated on scenes in and around Newburgh; the beach, dunes and sea. George lives in Peterhead so his work features scenes from slightly

further up the coast. The art going public we encountered were very enthusiastic about our work which is always a great boost, and by the end of the exhibition there were lots of red dots up on the walls so it was well worth the effort.

I would encourage anyone who has never visited a NEOS exhibitor before to look out for the catalogue next year which is available free in many shops, cafes, restaurants and libraries. It details the exhibitors and shows a picture of their work which you can use to help decide who to visit. I can guarantee they will be very pleased to see you and you may even pick up a bargain - an original piece of art without having to pay the commission fee of a professional gallery!

For more info on our work you can visit www.jbradfordart.co.uk & www.northernlight.org.uk



CRAFTYCO

19 Main Street
Newburgh

Open: Monday, Tuesday, Wednesday and Friday 10am – 4pm

We sell craft materials/kits and hand-made gifts & cards

Freshly made tea and coffee to sit in or take away

Workshops and Parties for children and adults. Various times available.

Simple alterations and help with sewing.

Drop in support for beginners in Crochet (Monday/Tuesday, Knitting (Wednesday/Friday during opening hours.

If you have an idea and need materials and support to achieve this, drop in for a chat and if we can help we will.

We will be open Sunday 15th November with our Christmas display for you to see/purchase 10am – 4pm.

Everyone welcome.

There are workshops planned for November and December so watch our window for details.

If you need more information, please call us on 01358 789589

Email: craftycocrafts@yahoo.com or message us on Facebook – craftyco.

NEWBURGH WRI

On March 20th and 21st the our Concert Party staged another successful concert in the Public Hall raising £1025, of which £800 was donated to Marie Curie Cancer Care and remainder given to Newburgh Public Hall to support its upkeep. We were delighted to have raised so much money locally and wish to thank all those who attended and all the companies both in Newburgh and Ellon who generously donated prizes for the raffle.

At our Business Meeting in April we were entertained by members of Esslemont Institute with a varied programme after the Annual Awards were presented and a new Committee was elected.

Members and guests of the Rural gathered on 10th April in the local Golf Club to celebrate their Institute's 60th birthday. As the oldest original member Mrs Betty Wood was invited to cut the birthday cake and was then presented with a badge and floral basket to mark her Honorary Membership of the Institute; this was conferred by Mrs Helen Smilie , Ellon Group Chairwoman. After a delicious meal we were entertained by Mr Scott Armstrong and his pianist with songs, stories and local jokes which were much enjoyed by all. After tea/coffee, birthday cake and shortbread we headed home after an excellent evening to mark our special birthday.

The speaker at our May meeting was Rev. James Falconer, the health care chaplain at ARI who spoke about the forthcoming roof garden which is hoped will open in August at Foresterhill. The Royal Bank of Canada has donated their winning garden at 2011 Chelsea Flower Show to the hospital and Rev Falconer has been fundraising since then. He showed us a video of the garden which will have therapeutic benefits for long term patients and their relatives. Rev, Falconer was hugely entertaining and enthusiastic, giving us an evening to remember.

Our speaker in June was Kira Pirie of the Chocolate Bar in Ellon whose subject was the History of Chocolate – her passion and obsession which she shared with everyone. Kira gave us several tips, including the use of a hairdryer to melt chocolate easily, and then passed around dishes for us to taste the plain roasted beans and then some with different flavourings which had been added, including one of Earl Grey tea which really surprised us. A very popular speaker to close our meetings for the summer break.

Newburgh Rural went on their summer outing to Brechin Castle Garden Centre, then Abernaye Antiques followed by a high tea in Montrose.

On 9th September President Mrs Jean Robertson welcomed members back after the summer break and introduced Dr Fiona-Jane Brown our speaker for the evening. Dr Brown set up “Hidden Aberdeen Tours” in July 2011 and conducts corporate and public tours as well as 12 History Walks and 5 Ghost/Crime Walks. With colleagues she has produced a video telling the story of Johnny Milne, Aberdeen’s last hangman. We really enjoyed hearing some of Aberdeen’s colourful history and Dr Brown has now published a new book entitled “Aberdeenshire – The Land”.

In October we were joined by Linsey Gibb who designs stained glass products in her home in Inch, where she runs a class in her studio for folk wanting to learn the craft. She demonstrated how to draw, cut and shape an article, outline it in copper foil using a soldering iron and then attach a chain to hang it. This talented lady also takes on commissions.

By the time you are reading this we will have had our November meeting which will be a talk on Aberdeen Harbour by Mr Colin Parker the Harbour Master.

On 1st December we will hold our Christmas Party for all members to attend.

Details of all our activities can be obtained from Mrs Rose Moroney –Tel: 01358 789353. Newburgh WRI meets on the first Tuesday of the month at 7.30pm in the Public Hall .

Jan McAndrew. Press Secretary

Chris Humes
Ellon Vet Surgeon
is a mobile Veterinary Service

***Our vet will visit you in your home to
treat***

and care for your pets:

***We provide scheduled appointments
to our***

registered clients

***within a 15 miles radius of our
practice***

24 hour emergency service

Tel No 01358 – 723420

Emergency No. 7835139761

***www.chrishumes.vet –
vet@chrishumes.vet***

***Trading from Esslemont Ind. Estate. Ellon
AB41 8NW***

**HOT STONE REFLEXOLOGY &
INDIAN HEAD MASSAGE**

For your ultimate relaxation and well-being



Now available from your local professional

MARIAN JOYCE GSSR

Member of the International Federation of Reflexologists
and over 15 years of experience and care

Home visits and Gift cards for loved ones are available

Phone Number: 01358 789489

Or email: marian.joyce@tiscali.co.uk



1st Newburgh Rainbows

Rainbows have been busy since our last update. Before the summer holidays, the girls took part in “Rainbow Riot” with all the other Rainbow Units in the Gordon County Area. They enjoyed making music, trying out circus activities, a climbing wall, bouncy castles and a magic show. At the end all the Rainbows joined together for a disco. We then said goodbye to quite a few girls at the end of June, with most going on to join Brownies in Newburgh. Since returning in August, we have welcomed some more girls into Rainbows.

At the start of September we all went on an outing to Newburgh beach where we had fun playing games and making sandcastles. Each girl helped collect a pebble which was then decorated the following week with lots of shiny paint and glitter. We have also had an outing to the park and played games outside before the nights became too dark.

This year the girls are working on their Festivals Roundabout badge and the first challenge they chose was to make puppets and tell jokes. All the puppets made were fantastic and they all knew plenty of jokes. Well done Rainbows.

For the Roundabout badges, all the girls take part in 4 activities throughout the year. Each activity chosen comes from a different section for the badge. The 4 sections are: Look, Learn, Laugh and Love. Within each section there are lots of activities to choose from and the girls get to decide which activity to try.

In the run up to Christmas we have some more girls joining and we will be doing some Christmas crafts and have planned a special treat at the Christmas party for them all.

We hope all our Rainbows, Parents, Helpers and Leaders have a lovely Christmas and look forward to the new term starting in January. A big thank you to all those who have helped and supported us throughout this year – without you there would be no Rainbows. We wish everyone a Merry Christmas.

If anyone would like to find out more about Rainbows, whether to register your child or to volunteer, more information can be found at https://www.girlguiding.org.uk/get_involved.aspx or if you would like more information about joining or volunteering with 1st Newburgh Rainbows please contact Lynsey on 07743 797377.

George W Emslie Ltd Joiner & Building Contractor

Joiners Yard:
Inch Road
Newburgh
AB41 6BQ

Tel 01358 721330

**House extensions, alterations and renovations.
Laminate and solid wood flooring.
Replacement skirtings, facings. Mirror doors
New windows and doors - wood and PVCU
Fitted Kitchens, bedrooms, bathrooms.
Replacement permadri garage roofs.**



The
Fairways
Pre-paid
Funeral
Plan

**To help her family when the time comes,
Alice has tended to her own Funeral Plan**

It's better to be remembered for the good things you do in life. By planning ahead with a Fairways Pre-paid Funeral Plan you can ensure that your family will be left with happy memories, not money worries. Unlike some Funeral Plan providers our Plans are fully guaranteed, which means no matter how much funeral costs increase there will be no more to pay when the time comes*.

Leave fond memories, not financial burdens.

G. Burgess & Son Funeral Directors

For a personalised Plan that's kept safe until you need it call our funeral home listed below or visit www.gb urgessfuner aldirectors.co.uk

Your local Funeral Director available 24 hours a day, 7 days a week

Station Road, Ellon, AB419AR 01358 720 259

Calling us on an 01 number is classed as a Geographic Rate call. If you have 'inclusive minutes' with your package these calls are included, however, you may wish to check with your call provider. Funeral Services Limited (30808R) is a registered society, trading as The Co-operative Funeralcare and G. Burgess & Son, with registered office at 1 Angel Square, Manchester, M60 0AG. Funeral Services Limited is part of Co-operative Group Limited (525R).

*T&Cs apply, see <http://www.gb urgessfuner aldirectors.co.uk/terms-and-conditions/>

FPA
FUNERAL
PLANNING
AUTHORITY
REGISTERED





Newburgh-on-Ythan Golf Club

(Website address: <http://www.newburghgolfclub.co.uk>)

Greetings from the Clubhouse

The golfing season has drawn to a close and each year it seems to get shorter and shorter. We were blessed with some milder conditions in the later part of the season and hope that some forecasters' predictions of a harsh winter prove fruitless!

Although the summer season is over, this does not mean our course is closed. Far be it from this. We currently have winter Membership available from now until the middle of March 2016 for those who prefer not to hibernate.

The following is available: -

Weekday £100

Seven Day £150

Take out full membership in 2016 minus your Winter Fee!

Our Club's AGM is being held on Monday 23rd November

On the social side, we are gearing up for Christmas and the following events are being held in the clubhouse in December: -

Bring a Party to a Party – Friday 18th

Children's Christmas Party – Sunday 20th

Hogmanay Carvery & Disco – Thursday 31st

Our caterer Martin has put together a Christmas Menu and this will be available from Monday 30th November.

We also have another very popular Breakneck Comedy Night booked for Saturday 30th January 2016.

- For £15 a year, as a Full Social Member, you can enjoy all the facilities that we have during the morning, lunchtime, afternoon and evening.
- Alternatively, for £5 a year, you can become a Lunchtime Social Member which would allow you to visit the Club at lunchtimes to have lunch, enjoy a drink from the bar or just a cup of coffee with your friends.

If you would like to join our Club as a Member, feel free to visit our Clubhouse and we will be happy to show you round. If you are interested in any of the above Social Events, then contact Shona Reid, our Club Manager, (01358) 789058 option 2.

Wishing you all the best for the up-and-coming Festive Season.

ABERDEENSHIRE LITTER INITIATIVE (ALI)

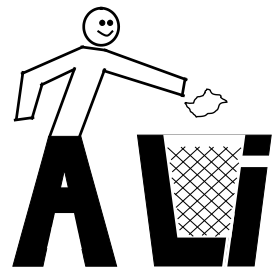

ALI is looking for volunteer litter pickers throughout the Foveran Community Council region to keep our villages clean and tidy

If you can spare an hour or so every so often to keep your street or the area around where you live free of litter then we would love to hear from you

High Viz vest, and litter pickers are provided

Contact Glen Douglas on 01358 789761 for more information



SERVICE  **MOT's**  **REPAIR's**

NOW UNDER NEW MANAGEMENT

Newburgh Motors Ltd, Loanhead Croft, Ellon AB41 6AN

Tel: 01358 789395

www.NewburghMotors.co.uk

After 40 years, Frank Stephen has decided to retire, and he and Alison wish to thank all their customers for supporting them during their time at Newburgh

Graeme Michael has taken over the business and we wish him every success.

LEARN TO FLY
AT ABERDEEN
INTERNATIONAL
AIRPORT

From a one off trial lesson as a gift, right through to getting your licence, Cabro Aviation can help you all the way.



www.cabroaviation.co.uk



K.F. Watson Electrical

Commercial - Industrial - Domestic



Ellon: 01358 789739
Aberdeen: 01224 566450
www.kfwatsonelectrical.co.uk

"JOBGING A SPECIALITY"

Outside sockets & security lights,
Extra sockets & telephone points,
Loft lights & power to sheds,
Oven/cooker repairs,
Down lights,
Replacement trip style fuse boxes,
Mains wired smoke detectors,
Electric showers,
Extract fan installations,
Electric under floor heating.

SELECT

Building Standards
Approved Certifier



Free Estimates
& Advice

All Electrical Work Undertaken
Our Prices won't SHOCK you

From a Socket
to a Rewire

Aberdeenshire Laptop Repairs Computer Repairs And Upgrades

Based in Balmedie, we provide a range of computer repair services within the Aberdeenshire area.

- PC Crashing or Freezing, Boot Problems
 - Blue Screens or Windows Errors
 - Virus Removal
 - Screen Replacement
 - Keyboard Replacement

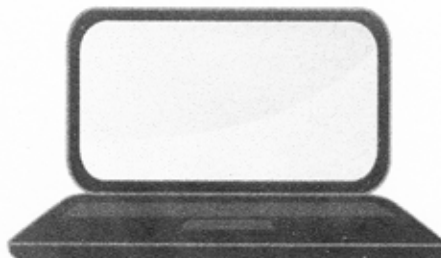

We can collect or you can drop your system off to us.

Tel: 01358 742647 Mobile: 07577 362677
Email: repairs@aberdeenshirelaptoprepairs.co.uk
Web: www.aberdeenshirelaptoprepairs.co.uk

FOVERAN



L-R: Alison Leslie, David Rait, Charlotte Rait, Gladys Rennie, David Rennie, Christine Fordyce, Marian Joyce.

Well done Foveran for winning a Highly Commended certificate in this year's Formartine in Bloom competition! There were lots of colourful displays of flowers and shrubs along the road and in the hall car park - with lots of hard work going into the planting and watering. The "Team" pictured above do a great job but would be very grateful for a few more volunteers so, if you've got an hour or two spare and would like to help, please contact David Rennie (01358 789426)

The Hall Committee is in the process of applying for grants for refurbishment.

Foveran Hall is available for hire so if you feel a party coming on or need a venue for your Club, contact Davie Rennie.

CULTERCULLEN and UDNY STATION



Karen and Kenny Mair. Winner of Best Village Garden.

BEST VILLAGE GARDEN: Congratulations to this year's winners Karen and Kenny Mair of Cherry Row. They were presented with the Cup and a cheque for £30. Thank you to Neil Fraser, last year's winner for judging the gardens.

FORMARTINE IN BLOOM: Udney Station was awarded a Highly Commended Certificate in this year's competition. As there are so few people in the Amenities Group we were delighted to have achieved this accolade. A special mention must go to Barbara Reid who designed the displays.

VOLUNTEERS: The group is always looking for new volunteers. There is no obligation to attend the meetings but a few extra hands would be very welcome. If anyone is interested please contact Alice on 01651 842268.

FLOWER BOXES: We are hoping to buy more flower boxes like those at the front of the Centre for next year's displays. As they are quite costly we can only replace a few at a time but hopefully we can continue to do this when the funding is available.

RAILWAY BENCH: We are hoping to take ownership of a bench which came from the railway platform in Udney Station when there was a station here. It is in need of a little refurbishment but we hope to have it in situ in the near future.

SPRING FLOWERS: We will have a spring flowers display this year as the Council has offered to give communities £250 worth of bulbs as well as polyanthus plants.

From everyone in the Amenities Group I would like to take this opportunity to wish everyone a Very Merry Xmas and a Happy New Year

CULTERCULLEN WRI.

Cultercullen SWI returned after their summer break on Tuesday 8th September. Their guests were Susan and Neil Smith of Painteramics. After a brief explanation about their company, Susan and Neil invited members to paint their own ceramics.

Competition results were as follows: Item in Decopatch: 1st Eileen Andrew; 2nd Carol Ritchie; 3rd Liz Webster. 2 Cheesecakes 1st Carol Hay; 2nd Moreen Alexander; 3rd Helen Thain. Flower of the Month 1st Sheila Johnston; 2nd Helen Thain; 3rd Carol Hay. The next meeting is on the 13th October when Shelagh Swanson will be giving a talk on glass making.

Cultercullen WRI held their October meeting on the 13th October in Udney Station. Their guest speaker was Shelagh Swanson of Oil and Glass in Aberdeen. Shelagh gave the ladies an insight into how she got involved in glass making and the path that led to her opening her Aberdeen shop. She brought along samples of glass making and paintings for the ladies to look at.

Competition results were as follows: Cross Stitch in Autumn Colours: 1st Maureen Alexander, 2nd Carol Hay, 3rd Carol Ritchie. 2 Fish Cakes: 1st Eileen Alexander, 2nd Carol Ritchie, 3rd Sheila Johnson. Flower of the Month: 1st Maureen Alexander, 2nd Sheila Johnston, 3rd Carol Ritchie.

A vote of thanks was given by Barbara Reid. The next meeting will be held on the 10th November 2015 with a talk from Pat Edwards entitled Change. All are welcome.

NEW COMMUNITY PARK

In August 2015, the residents of Cultercullen joined forces to support the purchase of approximately 2 acres of land adjacent to Rosedale, Cultercullen. Donations from residents to cover the purchase of the land and the legal costs have already been received including a generous £500.00 donation from Foveran Community Council. The project however will require the generation of further funding; applications to trust funders are underway and awaiting decision. Donations are also welcome – please contact 01651 842228 or 01651 842440 for details.

The plan to convert the land into a community park with new boundary fencing, hard standing area at main entrance and a hardcore path leading from the main entrance gate to another gate at the far end of the park opening into the school playground. The plan for the park includes tree planting at the westerly end leading through to a wildflower meadow following into an area with benches, tables etc. There will also be an area for school children to utilise for probably an outdoor classroom, planting area and wildlife interests or as they see fit. The most important factor is that the park provides a recreation facility for the village.

A Scottish Charitable Incorporated Organisation (SCIO) has been set up as the vehicle through which to run the Cultercullen Community Park. An SCIO is a legal structure that has been purpose built for the charity sector in Scotland. It provides limited liability and a separate legal identity to organisations that want to become charities but do not want or need the complex structure of company law. This means that the smallest charity can access the benefits of incorporation – including limited liability and legal capacity.

IAN ALEXANDER JOINER

**No job too small.
All joinery work undertaken.
Extensions, hardwood floors, skirting,
facing, dado rails, jobbing, maintenance,
kitchens, doors, glazing etc.**

**PHONE IAN ON: 01358 789369
MOBILE: 07710893222
FAX: 01358 788052**



Ellon and District Cats Protection
is always in need of:

- Loving homes for cats and kittens of all ages.
- Country homes for timid, outdoor cats e.g. stables, farms.
- Donations of goods for sales tables and Tombola.
- Volunteers to help with our work.

Contact us on (01358) 721204/723314
Email: elloncp@hotmail.co.uk
Or visit our website: www.cats.org.uk/ellon
Reg. Charity 203644 (England & Wales)
SC037711 (Scotland)



KR STEEL
SERVICES LIMITED

Specialist in Challenging Contracts

Our Services Include:

- Steelwork
- Fabrication
- Cladding
- Domestic & Commercial Works
- Plant Shifting
- On/Offshore Installations
- Timber Kit Manufacture & Installation



Call 01358 788907 for your **FREE** Quote

Casa Baya | Newburgh | Aberdeenshire | AB41 6BX
t/f: 01358 788 907 | e: info@krsteel.co.uk | w: www.krsteel.co.uk

Giving you Peace of Mind, Body & Spirit

We offer healing crystals, precious and semi-precious gemstones, Angel and Tarot cards, books, music, incense and cold-pressed, aromatherapy oils, Shamanic tools and wooden carvings, gifts and jewellery.

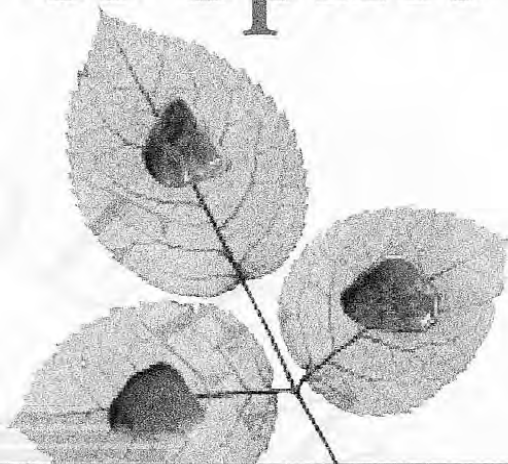

Many unusual Christmas gift ideas!

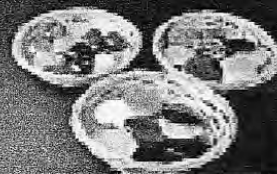
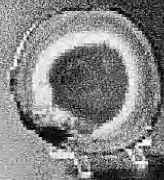

Gift Vouchers are available in store to give your loved one a pamper treatment as a surprise gift or for a birthday treat. They can also be used to buy crystals and gift items from the shop.

Crystals, Minerals, Gems, New Age Products and Therapies

Jules Healing Gems

Unit 2, Ellon Shopping Centre, Bridge Street, Ellon AB41 9AA

| Tel: 01358 724440 | www.juleshealinggems.co.uk

A Walk on the Wildside

Fit like everyone, once again it is time to take your reading glasses for a walk into the great outdoors and discover what Dame Nature has on offer for your delectation. That is of course if you have time to 'stand and stare' in between decorating your tree, hanging bits of another tree onto the front door and dangling bits of yet another tree above the door, in the hope of a sneaky kiss! Yes you only have a few weeks remaining to get that letter sent up the lum to yours truly.

You only have to take a brief look outside at this time of the year to see what this time of the year is. Even when we get some sunny days the skies grow grey with the massed ranks of grey geese as they move to and from feeding grounds. Yes, Christmas is coming and the geese are? Well they are already fat by the time that they arrive with us having flown from as far away as Greenland. Most of the ones that darken out skies or fields are pink-footed geese; their cousins the greylag geese normally go further inland to sites such as the Dinnet Lochs well up Deeside. Other avian species that favour this area for the winter are the superb whooper swan that travel from Iceland. Much closer to home the superb golden plover will dazzle watchers as large flocks tumble about in the sky. They have been up in the Cairngorms during the summer and bring with them a much smaller bird that enjoys a winter holiday along the coast, namely the snow bunting. It is a lovely wee bird that can be seen in small flocks in among the dunes, where they feed on marram grass seeds.

Sadly most of the plant life has gone to sleep for the winter but I did say *most* of the plant life. Now that the flowering plants are dormant and cosy in their wee beds until spring, there is the opportunity to look at one group of plants that are normally overlooked and certainly not full understood by the majority of folk: the lichens. Umm what are they? An understandable reaction from the majority but they are fascinating plants. Lichens are complicated plants normally found growing on the ground, on tree trunks, dry-stane dykes and even on the roofs of buildings. Yes they are the green or yellow encrustations that you might see on slates or tiles of an old roof. Complicated plant indeed, oh yes very much so. They are not like daisies or dandelions that flower but more like fungi that produce spores as a means of producing more lichens. And fungi is in fact what they are, well partially as in reality they are two types of plant that have decided to get married and live together for ever. Lichens have an inner layer of fungal cells and an outer layer of algal cells, phew work that lot out! They live in symbiosis with each other and that means that they both benefit from the others company, is that complicated enough for you? Few lichen species have common names but some are grouped together as 'reindeer

moss'. No they are not a moss but reindeers do eat them. Some of you good folk might have come across the name crottle, well that is another lichen that was/is used to make a reddish brown dye for colouring tweed. The Devil's matchsticks is a greenish lichen that has tiny stalks tipped bright red, just like a match! You can look for all of these locally especially on the moorland areas along the coast.

But to end where I began with a mention of the fast approaching 'season of goodwill', oh dear! I am sure that some of you still rely on tradition and have a *real* tree to decorate. In the past it would have been a Norway spruce but today the Nordman fir has become more popular with even Scots pine favoured by some. The tree to hang on the front door is of course holly and from way back in time it has always been held in esteem as a 'magical' tree. It has green leaves in winter but better still it bears fruit; the berries, in winter, and red is a potent source to ward off evil spirits, whoooo! Finally one tree, or more correctly woody plant that grows on trees, that you must definitely have in your house is mistletoe. Back to the strange and weird plant category with this one as it is a parasitic plant that grows on trees; apple trees are a favourite host, where it sends its roots into the trunk to tap into the tree's food source. It has sickly green leaves, as it does not need to make its own food using green chlorophyll. Be warned, a sneaky smack of the lips is fine but do not eat the berries, they are very poisonous.

Have a great Christmas and enjoy the great outdoors right through 2016.

Take care of yourselves and our wildlife until the next edition. Byeeee.

Bob Davis

Deeside from the air - Let's go fly a Glider

Take a flight in a 2-seat Glider over Royal Deeside from Aboyne, where you will be shown how to fly, and get the opportunity to take control

Flight gift vouchers are available which make ideal Christmas and Birthday presents, Initial cost only £75.00 and includes 3 months membership of Deeside Gliding Club.

Subsequent flights typically around £38-£40.

You can fly a Glider solo at 14, but you cannot learn to drive a car till you are 17

Buy on line at www.deesideglidingclub.co.uk, or phone 013398 85339

D & W WHEEL RESTORERS



★ BLAST CLEANING

★ POWDER COATING

★ ALLOYGATOR RIM PROTECTORS

★ TYRE REMOVAL & REFITTING

★ WHEEL BALANCING

Powder Coating also available on
Motorcycles ★ Suspension ★ Engine Parts ★ Bike Frames
and many more other parts.

Unit 1 Loanhead Industrial Est. Newburgh, Ellon
Mob: 07808778809

NEED A LOCAL ELECTRICIAN?

TT Electrical Services

For all your Domestic and Commercial Electrical Work

Wireless Burglar Alarms fully fitted from £350

Full and Partial Rewires

Extra Lights and Sockets

Fuse Board Upgrades

PAT Testing

Security Lights

New Builds

Tony Tortolano

2 Holyrood Cottages,
Newburgh. Aberdeenshire.

Call Tony for a free estimate.

Mob: 0798 3604609

Landline: 01358 789762

ttelectricalservices@yahoo.com

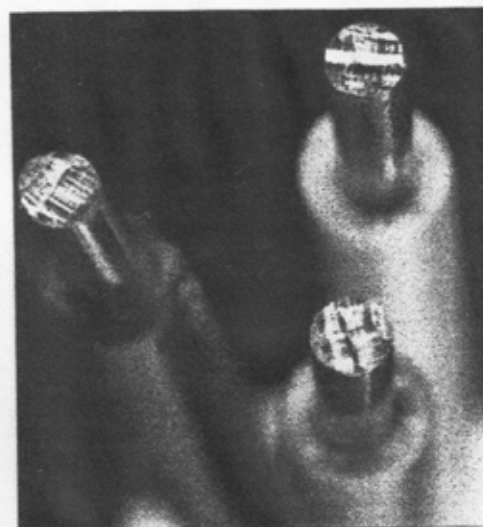



Forvie National Nature Reserve

We have very much enjoyed collecting sightings of all things furry at Forvie in the last few months!

The North East Scotland Biological Records Centre (Nesbrec) has been appealing for sightings of the mammals found in our area and all the way to the Cairngorms. These sightings could help animals to be protected, could improve our understanding of how mammals move from one area to another and whether climate change or other factors affect which mammals are found locally.

Foxes, voles and roe deer are commonly seen at Forvie, but we had to do some detective work to find evidence of the lesser seen creatures such as bats and otters.

Some of the most common animals are never reported, so rabbits and mole hills were all noted as well as anything unfortunately seen at the side of roads.

Excitingly, we found evidence that a water vole had visited one of our floating rafts next to the Ythan, which has a clay pad on it. Any animals that walk over the clay leave their footprints, or quite often in the case of otters, mark their territory with droppings called spraint. The water vole had left its droppings too.

The raft pads have shown that the Ythan has its regular otters and brown rats but not American mink, which is one species we wouldn't want to see back.

We also hosted a bat detector at a couple of places along the Ythan and were astonished to record thousands of bat clicks from 3 different species of bat, which were common and soprano pipistrelle and Daubenton's bats. The bat detector can distinguish species by the sound frequency of the calls each bat makes.

Other mammals we spotted this summer were brown hares in fields near Forvie, red squirrels at Auchmacoy and of course, grey seals. Disappointingly however,

hedgehogs have only ever been recorded a couple of times on the reserve. Also shrews were heard, but only found dead on paths.

You can still send your animal records to Nesbrec via their website at any time, so enjoy any winter wildlife watching you can!

Annabel Drysdale, Reserve Manger

Annabel.drysdale@snh.gov.uk

01358 751330



Musical Plants

I seem to have been playing 'musical plants' again! And this summer has been perfect for it with it being so wet. The plants I have been moving in my garden are not too big, but it is possible to move really very large specimens. The larger landscaping companies have an amazing motorised piece of equipment that is dropped over the tree or large shrub, and cut into the earth all around its root, creating an enormous root ball, then lifts it up in a huge ball of earth, to be replanted in the desired place, so the plant is not really disturbed too much. 'Us' mere mortals, without this equipment, can still move substantial specimens though, as did gardeners of old.

If the move is planned well enough in advance, we can prepare the plant beforehand and all this equipment is not needed. In the previous year before the planned move, a deep cut can be made around the specimen. It is made at least the canopies width, and at a couple of spades depth, cutting through whatever roots are there. This spurs the plant into making the new fine roots that are needed to take in nutrients – the large fat roots are the plants anchor, and we can supply support for it until the plant re-establishes itself.

Of course this all depends on the ability to actually physically move the said specimen. Whilst I was at college, we did move some enormous plants, but there was a number of us all working together, and we had done the preparation beforehand. We didn't lose any of them, but they needed a lot of after care. A good way to get water down to the roots is to cut a short length of hose and bury one end under the plant leaving the other end at soil level. A funnel is attached to the exposed end enabling water to be poured down the hose right into the moved root system. It will need masses of water. Not just a sprinkling, but several buckets full at regular intervals throughout the year after the move.

One can buy huge trees from specialist nurseries for instant effect, and they are beautiful, if very pricy and they need a lot of after care. These are wonderful in a sheltered site, but I feel that a more successful path in an exposed site is, to plant tiny trees in tubes, to allow them time to build up a good root system both for stability and nutrition, before they stick their heads out of the tube into the elements!

Back to my 'planty' party games, all done for the time being, although I can see me moving more at a later date. I even have a few spaces to fill, and that is always good. I can see a nursery visit on the horizon, although one of my college lecturers has asked me to house some rather special plants for him, so I will have to find somewhere for them to go and make sure I really look after them!!

Happy Gardening!

Lesley Barnett

Ythan Waves

Ladies & gents
Hair and Beauty

63 Main Street
Newburgh

01358 789090

All Aspects of Hair and Beauty

GEL EXTENSIONS (over 70 colours)

SPRAY TANS *EYELASH EXTENSIONS*

FAITH LIFT FACIALS *waxing*

Kebelo hair smoothing treatment

Hair ups

Book now to avoid disappointment



Follow us on Facebook
/ Ythan Waves

James Walker 1848 – 1882 by Charles Catto.

It is sometimes quite strange what passes over the editor's kitchen table (desk). And this must be up there as one of the strangest requests of all.

Towards the end of the year 2013 Mrs Janet Jones, Editor of Foveran Community Newsletter received a letter addressed as such.

The letter was from a lady by the name of Lola of Almeria, Spain. Unfortunately the letter had no sender's address. She describes Almeria as a little town but it is in fact comparable in size to Aberdeen. It is situated some 130 miles east of Malaga. It is also highly recommended as a holiday destination by Tripadvisor – not a touristy destination but a city and surroundings steeped in the past history of Spain. It was also close to Almeria that Sergio Leone filmed Clint Eastwood in “A Fistful of Dollars” the first of many “Spaghetti Westerns”.

The contents of Lola's letter explained that the town had a British Cemetery which she had discovered quite by chance, while attending the grave of her aunt who was buried close to hand in the Catholic Cemetery. In her own words “I felt very impressed seeing all those ancient tombs”. One tombstone in particular caught her eye which read as follows:-

Sacred to the memory

Of

James Walker

Mastership (sic) SS Thomas Adam

Died at Almeria

September 29th 1882

Aged 34

Second son of the late Alexander Walker

Bridgefoot Foveran Aberdeenshire

Scotland

Out of the kindness of her heart Lola regularly put flowers on some of the graves within this graveyard particularly the one of James Walker to commemorate and honour their memory.

Unfortunately Lola also mentioned that the Spanish Authorities were seeking to close this cemetery after exhumation of the remains which were to be placed in a common grave. The lady was most upset regarding this turn of events mentioning that there were many Scots buried there from a variety of towns from Shetland to the Central Belt. Most likely all mariners, since Almeria was a Mediterranean trading port.

Lola wrote to the British Consulate in Malaga but never heard back from them. She also spoke with the management of the cemetery who were “well-disposed to hand over the remains to someone who asks for them”.

Hence her reasons for looking for and finding a source on the internet: which was close to the home of James Walker.

James Walker was born at Bridgefoot, Foveran the second son of Alexander Walker and Mary Sophia Duncan in the year 1848. James was christened on February 18, 1848. Alexander at that time was a baker and innkeeper at the Ship Inn, Bridgefoot in what was to become the Ythan Hotel and now the Newburgh Inn.

James Walker went to sea probably after schooling at Newburgh Mather's School and on November 15th 1873 received his Certificate of Competency as a Master at the age of twenty five. Not much is known of his maritime career; suffice to say he was shipwrecked while sailing through the Gaspar Strait off Java while sailing to China in the Glenavon from Cardiff to Shanghai in June 1871. The Glenavon, a three masted sailing ship of 830 tons was built by Hood of Aberdeen. There was no loss of life by this shipwreck.

At a later date he became master of the SS Thomas Adam and it was while on this ship that he died at Almeria in Spain, at the age of 33 (age as on mariner's return). His death occurred on September 29th 1882. The SS Thomas Adam was also an Aberdeen built ship being built by Hall Russell in 1870. In 1882 the ship was owned by G P Addison & Co. and was surveyed in Shields. Its master was J. Walker.

We do know that he was married and that he lived in the King Street area of Aberdeen. He married an Isabella Jamieson (born 1848) of Slains and they had two children Mary Sophia Walker (born 1878) and Alexander Walker (born 1880).

The Spanish lady's concern is that she would like James Walker's remains to be returned to his home parish of Foveran before the destruction of the graveyard and the committal of all to a common grave. This may not be possible without the intervention of descendants of James Walker.

James Walker is commemorated on a family gravestone (217) in the Kirkyard of Foveran Church.

We have contact details of the British Consulate in Malaga and of the Honorary Consul in Almeria with whom the lady has tried to contact. Unfortunately she has not left us her own contact details. Her letter was written by hand and delivered by post so unfortunately there is also no email address either.

I contacted the British Embassy in Malaga and I also got no reply.

The death of James Walker in Spain has been confirmed by Scotland's People Maritime returns.

Information on the British cemetery is available on the internet and there are pictures of some of the gravestones but unfortunately not of the stone of James Walker.

In my desire to obtain a photograph of the gravestone and also not wishing to have my ex brother in law travel a considerable distance from his home in Spain, I did another trawl of the internet recently. This turned up an article by a David Jackson who writes blogs on issues around the Almeria area of Spain.

In an article posted in October 2014 he says that the town hall of Almeria has agreed a plan with the British Embassy to clean up and reopen the British Cemetery.

However when I made personal contact hopefully to obtain a photograph Mr Jackson was more pessimistic saying that he wasn't sure if the promised renovations had taken place.

Legally it appears that only a person related to James Walker can request the return of remains if they so desire.

There are many "English Cemeteries" in Spain. Used not only by the English but also for used others of many nations. They were deemed necessary for the burial of those who were not of the Catholic faith. However; many have fallen into disuse and are neglected by the local government who have other priorities for their local taxes. Not unlike the priorities applied by our own local councils. It does appear that some of

these cemeteries may indeed belong to the government of the United Kingdom, the Almeria cemetery having been sold for a token sum of 800 pesetas (one per square metre).

As the political situation between Spain and the United Kingdom is not a particularly good one it is difficult to see an appropriate outcome. Unfortunately there may nothing that can be done and we can only hope that the Spanish authorities do what is right.

Update from David Jackson who lives in Almeira.

In 1887, the town of Almería ceded in perpetuity, 888 square meters of land to be used as an “English cemetery” for Anglicans who died in the province.

Of course, in the glory days of Queen Vic, this sort of thing was all well and good, but what with civil wars, economic downfalls and the final setting of the sun upon the Empire, the place fell into disuse. The local Brits were usually happy with a standard hole in the wall or a cremation, and since there was nobody to look after the cemetery it was sealed off to public access, after part of a wall almost fell on some kids. Sometimes an Anglican in the know *would* die in the province, and the remains would be placed here – the last burial was in 1993.

Anyway, the town hall of Almería has agreed a plan with the British Embassy to clean up and reopen the *British* cemetery. The first cleanup has already commenced, the walls will be rebuilt, a new entrance is being designed, the British style mausoleums are being cleaned and propped back up, the Anglican Chapel is being restored and it's hoped the place will once again be used / or at least serve to drag some tourists in.

Read more <http://www.davidjackson.info/blog/2014/10/05/almerias-english-cemetery-will-reopen/>

LATE NEWS ALERT

As you will have seen in the press and TV, the Scottish government is considering a seal Haul out protection order for the Ythan estuary

This, if implemented, will stop you walking on the beach, as well as the Golf Club losing part of its course

If you wish you, your children and your grandchildren to enjoy the walks on Newburgh beach please object to this proposal by logging on to

<https://consult.scotland.gov.uk/marine-environment/possible-designation-of-a-seal-haul-out-site>

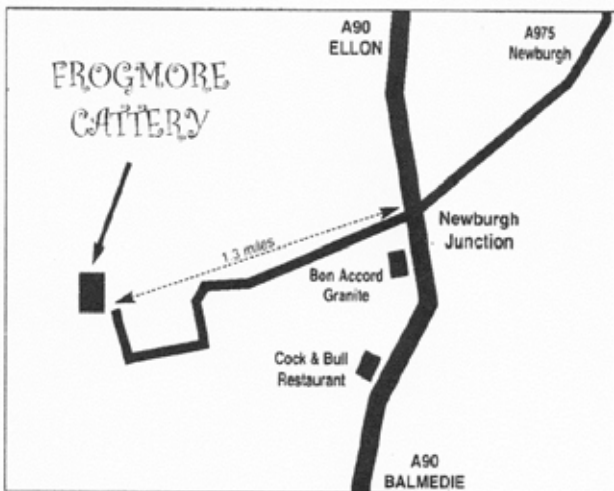
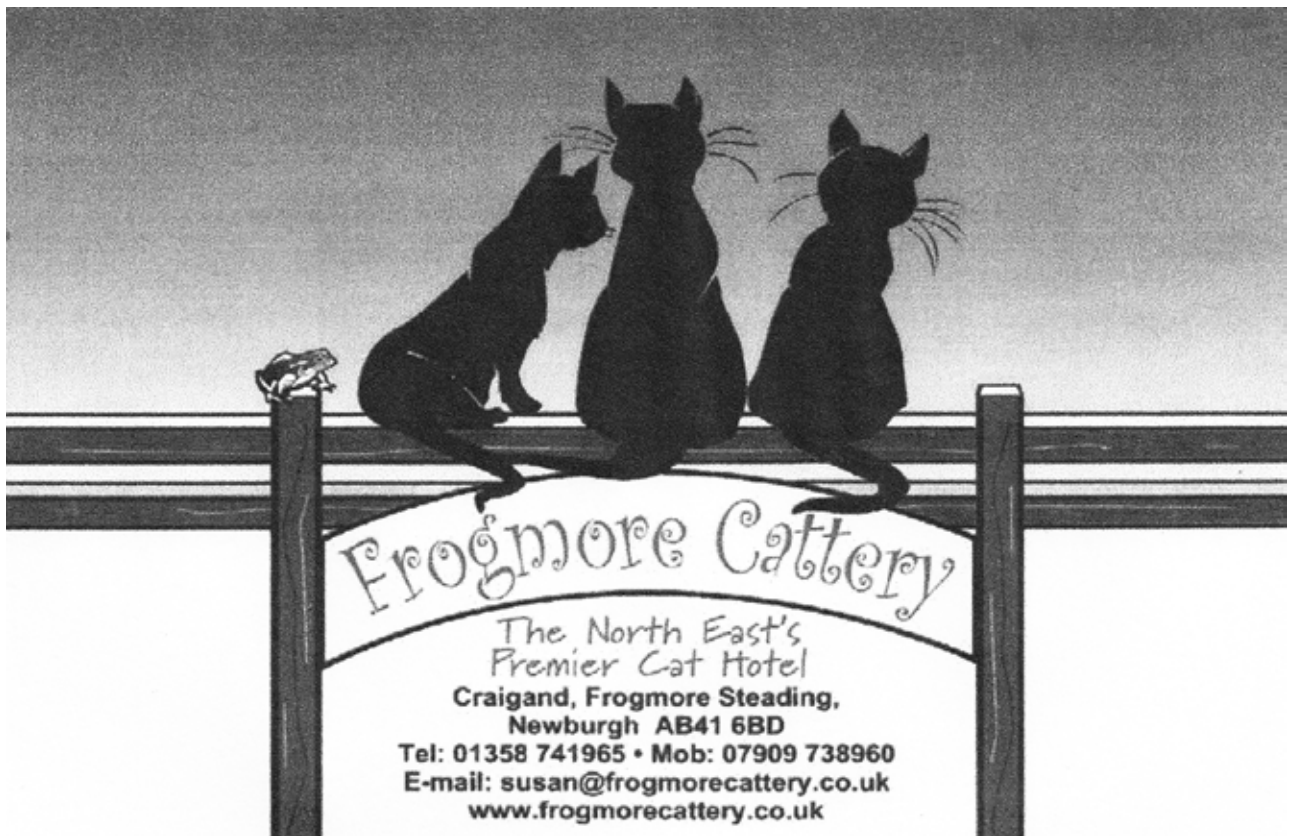

Frogmore Cattery

'The North-East's Premier Cat Hotel'

- **EXCLUSIVE MODERN ACCOMMODATION**
- **SPACIOUS INDOOR PENS**
- **INDIVIDUALLY HEATED BEDS**
- **EXCLUSIVE INDOOR PLAY AREA**
- **PEACEFUL COUNTRY SETTING**
- **COMPETITIVE RATES**
- **FRIENDLY AND CARING STAFF**

For Reservations please telephone:

T: 01358 741965

M: 07909 738960

MEDIATION



Mediation is a method of conflict resolution where dialogue between two or more parties in dispute is facilitated by a mediator. The aim is to assist the parties to move forward and where possible find an acceptable and workable solution to the dispute. Mediation is free at the point of delivery, voluntary, confidential and facilitated by trained and impartial mediators.

Aberdeen and Aberdeenshire Community Mediation Services are managed by Sacro and funded by Aberdeen and Aberdeenshire Councils through housing and community safety monies. The services have been working with communities since 1998 and have received over 3,600 referrals. Community Mediation services are available to all residents of Aberdeen and Aberdeenshire, regardless of tenure type, with referrals being received from partner agencies or directly from those involved in a dispute.

Reasons for conflict between neighbours are diverse but can include noise, children's behaviour, anti-social or abusive behaviour, boundary or property disputes. What starts as a minor disagreement can escalate into a full-blown dispute, causing stress and worry. Usually those involved in a dispute want it to stop but are unsure how to resolve the issues to everyone's satisfaction. Mediation provides an opportunity for all involved to acknowledge the past and discuss ways of moving forward in a calm and rational manner. The mediation meeting is structured so that everyone has the chance to speak and be listened to. The focus is on the future and how things will be, rather than on the past and how things were. Over 80% of all cases where mediation is used result in either full agreement or substantial improvement.

If you feel you could benefit from involvement with Aberdeen or Aberdeenshire Community Mediation Service, or if you would like more information, please contact Irene Reid on 01224 560572. Sacro, 110 Crown Street, Aberdeen, AB11 6HJ.



ABERDEEN VETERINARY REFERRALS

EXPERTISE WHEN YOU NEED IT

Aberdeen's first dedicated referral centre
Providing convenient and reliable treatment in:

Orthopaedics | Neurology | Oncology | Medicine
Spinal surgery | Soft Tissue surgery | Radioactive iodine treatment
Diagnostic imaging including CT and MRI Scanning

DISCUSS REFERRAL WITH YOUR VET!



Aberdeen Veterinary Referrals, Foveran, By Newburgh, Ellon, Aberdeenshire AB41 6AU
Tel: 01358789898 Email: info@avr.vet
www.aberdeenveterinaryreferrals.com

Local Police Inspector Jamie Harrison

I'm really pleased to say that we continue to experience low levels of crime in Formartine. However there is no room for complacency and I just wanted to give some basic advice and let you know about some of the things that I have planned for the coming month.

While we are fortunate to have low levels of housebreaking and theft, unfortunately we have recently seen a number of crimes throughout Formartine. These typically are committed by young men from Aberdeen who will come to the Shire seeking what they perceive to be 'soft targets'.

While we are pretty good at catching these individuals when crimes have been committed, I would rather that they didn't happen at all. By taking some basic security measures, making sure your home and cars are locked and not leaving valuables on display you can prevent yourself becoming a victim of crime.

As winter and the dark evenings get ever closer I would encourage everyone to make their homes look occupied especially when they are empty but also when they are occupied by ensuring there is lighting emanating from inside their homes as we launch our "Lights Out - You're Out" campaign.

The campaign will involve Officers on patrol, identifying homes which, due to their lack of light, appear unoccupied. Officers then deliver an After Dark card to the house which contains common sense advice on the rear.

This initiative has been running across Scotland for a number of years as a pro-active approach to reducing the chances of the people in our communities being the subject of criminal activity. The simple message remains the same. Make your home look occupied and secure your property and vehicles."

You will be aware of recent tragic fatal road traffic collisions around Formartine and in particular on the A90. These are being investigated by our Roads Policing department and provide a stark reminder to the possible devastating consequences of being involved in a collision, especially on our faster roads.

With darker nights, damper weather and, dare I say it frost on the horizon, I'd like to take the opportunity to remind everyone of the importance of driving according to the road and weather conditions and definitely to staying with the speed limits. Additionally, we have seen that speed, the use of mobile telephones and failure to wear seatbelts are all contributory factors to people being injured in collisions.

We regularly conduct speed checks on the roads around Formartine and the A90 in particular features on the Road Policing and Trunk Road Policing patrol plans. These officers will be actively looking for those speeding, using mobile telephones or not wearing a seatbelt. From a local Policing perspective I have been running an operation for the last month and plan to continue this going forward which will see your local officers on patrol at commuter times, again looking to make our roads safer by 'Education through Enforcement'.

Police can be contacted by calling 999 in an emergency, 101 or be emailing the Community Policing team at EllonDistrictCPT@Scotland.pnn.police.uk.

INGRAMS HOME CURE
EAST PITSCAFF
NEWBURGH
AB41 6AQ



We sell Home-Cured Bacon and Gammons
and
Home-Made Sausages from the Farm.

Opening Hours
Tuesday - Friday 1pm - 6pm
Saturday 10am - 5pm

Tel: (01358) 789548

From Newburgh, turn left at the sign for
Tahuna Livery, follow that road and take a right
to East Pitscuff.

We pride ourselves on the personalised service
& care we provide for your animals
... Consultations & Visits
By Appointment





METHLICK
01651
806212
Polesburn, Methlick
AB41 7DU

ELLON
01358
720223
23 The Square, Ellon
AB41 9JB

Well Equipped Medical &
Surgical Facilities
Family Pets
Farm Animals & Horses
Dermatology Referral Centre
Homeopathy
Heated Boarding Kennels

www.glenythanvetgroup.com

24 Hour Emergency Service

Costcutter
Supermarket, The Square, Ellon
Tel. 01358 720281

Free delivery
service in and
around Ellon

Top quality Fresh
Foods including
Beef from our
own local farms

Hydro tokens
and Mobile
Phone Top Up
Cards available

Newspapers and
Magazines seven
days from 7.15am
Monday to
Saturday and from
9am Sunday

Costcutter – your local friendly supermarket

ELLON AUTO REPAIRS



Body Repairs and Spray Painting
Private and Insurance Work Undertaken

Logie Road
Tipperty
Ellon AB41 8LT
Tel: (01358) 721110
Mobile: 07967 488096

Raymond Birnie

for award winning service...phone Phil

Phil Anderson Financial Services has been voted one of the Top Rated Independent Financial Advisers (IFAs) in the UK on consumer ratings site VouchedFor.



The accolade, which was awarded to Mr Anderson due to glowing reviews from his satisfied clients, follows closely to the Best Business Award for Corporate Social Responsibility given to the business in November 2013 for their involvement with local community and charities.



Mr Anderson who has offices in Aberdeen, Ellon and Caithness commented: "Being recognised as the top adviser in Aberdeenshire and a Top Rated Adviser in the whole of the UK is an amazing feeling. Financial advice is all about helping people to make the most of their hard earned money. In today's testing times it is more important than ever that people plan for the future. Speaking to an adviser can save you thousands, be that getting the right mortgage, pension, annuity or making the right decision with your savings."

for finance
for insurance
for clarity 
PHIL ANDERSON
financial services
for mortgages
for the future



philandersonfinancial.co.uk **web** | admin@philandersonfinancial.co.uk **email**
34 Market Street, Ellon, AB41 9JD | 01358 268166 **office**

Phil Anderson Financial Services Ltd is an appointed representative of Financial Limited, which is authorised and regulated by the Financial Conduct Authority

portraits · weddings · parties · graduations · pets · events · commercial · press



 **Paperdoll
Photography**

t. 01358 727003
m. 07852 205003

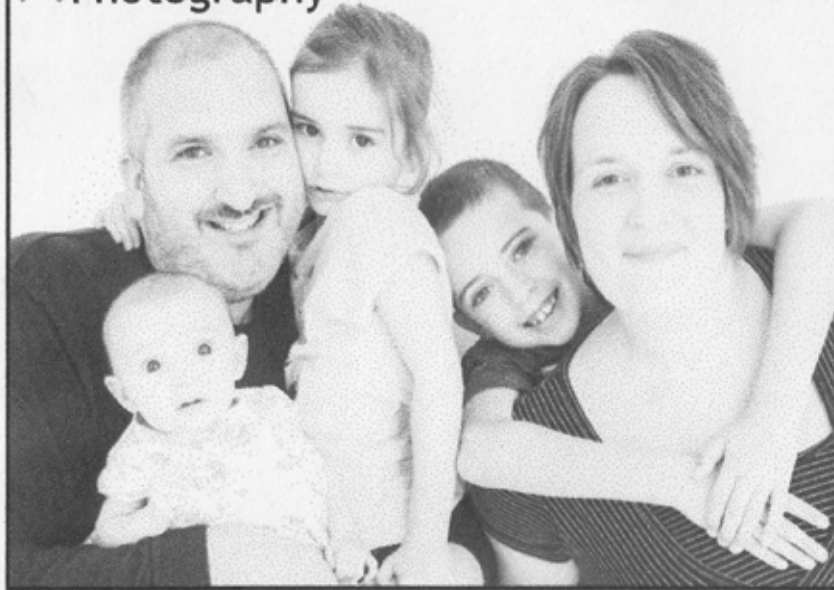

The Studio · 36 The Square · Ellon · AB41 9JB

www.paperdollphotography.co.uk



info@paperdollphotography.co.uk

Newburgh Public Hall

Foveran Community Council is working with the existing Hall Committee with a view to obtain funding to refurbish the hall facilities.

We need volunteers to step forward to assist the existing Hall Committee, and eventually take over the management of this facility which is extensively used by the residents of Newburgh.

If you can help in any way please contact Rose Moroney on 01358 789353

The Ythan Bakery

54 Bridge Street, Ellon
Aberdeenshire AB41 9AA
Telephone / Fax 01358 720607



Traditional Country Bakers
Celebration Cake Specialists
Hot Buffet Counter

Forvie Minefield

At the start of World War 2, Britain readied itself for an invasion by the Germans by setting up defences along virtually all of the Eastern coastline. Beach obstacles, anti-glider poles, barbed wire, scaffolding were all used. Other defences were systems that would spray oil into the sea then ignite it. One of the most widely-used defence weapons was the landmine. Over 350,000 mines were laid in over 2000 minefields in the UK. Little thought was given to the laying of minefields in that one day they would require to be cleared. When mine clearance started in WW2, it took in some cases until the 1970s to complete the clearance. During this time countless military, prisoners of war (used in mine clearance) and civilians had been killed or injured on British minefields.

At the start of the war, a review was undertaken by the War Office who identified the areas where an invasion was likely and proposed defences for the area. One of these areas was Forvie, or Newburgh as the records show. The long beach at Forvie was deemed to be a likely landing ground for forces due to the proximity to RAF Dyce, and the small harbour at Newburgh. With this in mind, the bridge over the Ythan at Newburgh had been wired up to be demolished if an invasion occurred.

In addition to the anti-tank blocks laid along beaches, Forvie had a minefield. This was listed in the April and October 1941 vulnerable beach review as “blocked by mines”. Mines were about 25kgs in weight and 12” in Diameter

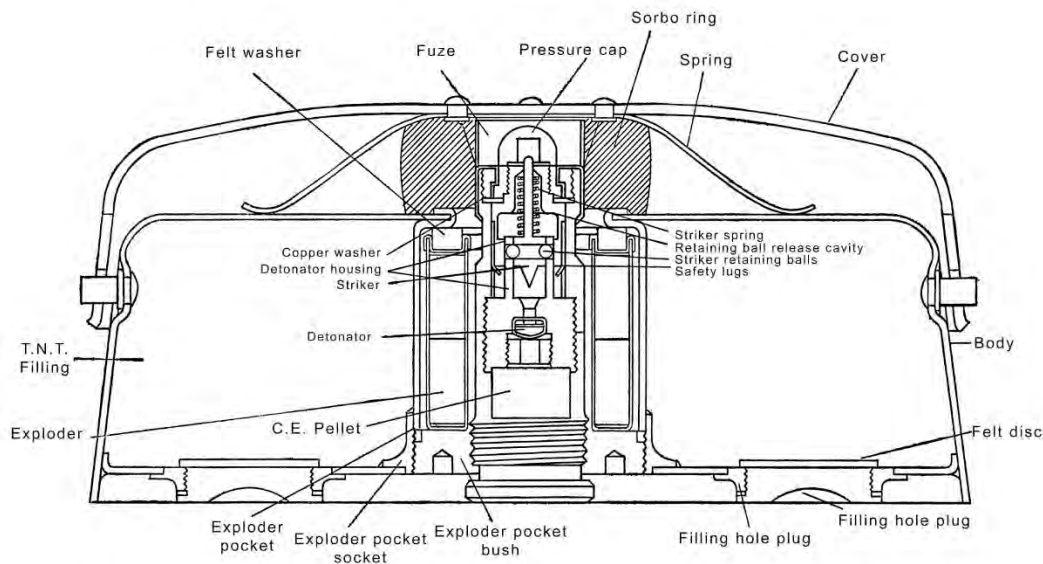

Drawing of a British Anti-tank landmine

Minefield no 20 (Newburgh) was basically a one mile strip of landmines within a fenced area, the strip would be approx. 25-50 meters wide and had several thousand mines laid. The minefield ran east to west basically from the Fishing Bothy area at the beach across to the Ythan Estuary. Mines were used to limit and impair movement

across an area, they were typically laid around areas of beach that access inland could be made.

14th June 1944 a letter was issued from Major W.E Hewitt of 11 Bomb Disposal Company (based in Edinburgh) to Lt W.M Brown instructing the Newburgh Minefield at map reference 31/521474 to 538472 to be cleared commencing Wednesday 21st June 1944. Suggesting due to hazardous gradients, work can progress from west to east. Mines recovered are to be exploded at the end of the day at 17:00 hrs daily. A company consisted of one officer, one sergeant and 29 other personnel.

Work commenced on 22nd to 30th June. The clearance of a larger minefield in St Fergus was also being done by the unit. Over the period 20th-31st July 1944 on clearing the minefield by 11th Company of the Royal Engineers Bomb Disposal. On 27th July 1944, 28 year old Sapper Harry Dean was killed on the minefield whilst clearing mines.

1-22nd August 1944, 222 mines yet to be dealt with. On 30th August to 4th Sept a court of inquiry was held into the death of Sapper Harry Dean.

October 1944, 222 mines yet to be dealt with.

1-7th October 1944, 84 mines cleared.

December 1944, 84 mines to be dealt with.

12th March 1945, burning of minefield took place to clear grass from the surface. This was presumably to carry out one last sweep. It is suspected that not all mines could be found. Forvie with shifting sands, inaccurate maps of mines and exact count of what was laid lead to a certificate being issued that mines have been cleared as far as possible and those remaining are not deemed a risk. In some examples in England, mines were found that weren't even on a map!



The photograph is of a converted Bren Gun Carrier being used as a flame thrower to clear minefields

1-15th July 1945, Clearance of fences around Newburgh Minefield.

1st of August then 6-10th August 1945, fences were finally cleared from the minefield.

It is not uncommon for mines to appear years after the war, one was found in 2012 near Newburgh, another on the Trump International golf course and on a golf course at Buckpool. Most likely now, 70 years on they have all but corroded away and harmless.

Sapper Harry Dean is buried in the Lawnswood Cemetery in Leeds. There are also records of bomb disposal personnel and children being lost at Peterhead and Murcar minefields during the war!

delicious.....

sandwich takeaway & coffee bar
Unit 1 Ellon Shopping Centre Bridge Street, Ellon

Sandwiches/Panini/Baguette/Wraps/Hot Food/Salad
Boxes/Home Bakes

Office/Home Delivery/Lunch Platters/Business Meetings/
Small Parties

01358 724600

tracygibb@hotmail.co.uk
www.delicioustakeaway.co.uk

**Free Local delivery
within 12 mile radius.
Minimum spend £15.
Mon - Fri 9am - 3pm
Sat 9am - 2pm**

Editor: Please may I have contributions for the April 2016 edition of the newsletter by the 6th of March. 01358 742304, South Minnes, Newburgh. Ellon. AB41 6BB
j.jones110@btinternet.com

KEY 'N EDGE (ELLON)

37A THE SQUARE
ELLON
01358 723555



KEY CUTTING, ENGRAVING
LOCKS SOLD/REPAIRED.
PICTURES/SEWINGS FRAMED,
GLASS REPLACED.



OPENING/CLOSING TIMES:
TUE./THUR./FRI. 9:30 – 1:30
SATURDAY 9:30 – 1:00



**Aberdeenshire
Larder**
SPECIALIST BUTCHER & GAME DEALER

Shop Hours:
Mon-Thurs: 8am – 4pm
Fri: 8am – 5pm
Sat: 8am – 2pm

“Where Customer and Service Come First”

Telephone: 01358 727857
www.aberdeenshirelarder.co.uk

Unit 3, Broomiesburn Road, Ellon
(turn left at JRD's)



dudwickmobilefootclinic
working towards a healthier community

Do you **suffer**
discomfort from ...

- Callus
- Corns
- Athletes Foot
- Ingrowing Toe Nails
- Fungal Infection

Treatment in the comfort of your own home

For treatment of foot-related problems contact:

Marguerite

Tel. No. 07814 768733

Evening and weekend calls available

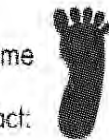

Marguerite Connolly

(S.A.C.) Dip Foot Health Practitioner
SRN, SCM, Dip Nurs(London), BA(Cancer Nursing)



Your Local

Bathroom & Boiler Specialist

- All types of Plumbing
- Bathroom Installations
- Central heating Installations
- Boiler and Repair Service
- Gas Certificate

Ross Paterson

M: 07947532200

T: Newburgh 01358 789111

Email: RGP.plumbingheating@yahoo.co.uk

FOVERAN PARISH CHURCH

Dates and Times of Services.

Christmas Tree Lighting and short service:	29 th November.	Time to be confirmed
Evening Carol Service:	13 th December.	6.30pm
Mulled Wine and Mince Pie Event :	19 th December.	TBC
Children's Christmas Service:	20 th December.	11am
Christingle Service:	24 th December.	4.30pm
Watchnight Service:	24 th December.	11.30pm Carols from 11pm
Christmas Service:	25 th December	10am

SOCIAL COMMITTEE REPORT

The HARVEST SUPPER DANCE on Saturday 2 October in the Newburgh Inn was much enjoyed by all those who attended. The evening began with a tasty supper – followed by dancing or just chatting with wonderful music provided by The Ythan Fiddlers. Thanks partly to the raffle we were able to raise the sum of £256 which will go towards the work of our mission partners in Malawi. The committee wishes to thank all those who supported the event in any way - we were delighted again to welcome many friends from Collieston and elsewhere in our local area.

Looking ahead - the annual KIRK ROUP will probably have already taken place on Saturday 21 November before you read this newsletter.

We are also beginning now to plan for our annual BURNS SUPPER early in the New Year – this is likely to take place on Saturday 23 January, so please put this date in your diaries.

Meanwhile the committee wish you all a very happy and meaningful Christmas season, and look forward to welcoming you to our social events in 2016.

Mary Smith (Social Convenor). Tel: 01358 742234

Christmas 2015

So, what is happening to the old Foveran Church?

It has been an involved if slow year this year. Distracted with stuff, how has your year been? Why do what things that appear to be a straight forward , take on a life of their own! Those are the questions facing me as we come to the end of the year.

In 2008 it was decided the old Church was no longer going to be used as the main Church center, and that it would be sold. In 2013, that permission to sell was withdrawn by the General Trustees in Edinburgh, and the time permitted to come up with a sale lapsed in 2014. This time last year, matters were being sorted out with the Church General Trustee's, Presbytery and the Congregation, and permission was again granted to pursue the sale of the building.

This past year has seen slow but – I hope - sure progress as the mechanics of a sale have been looked at and a plan developed to try and sort out the complexities of the task. You see, there is an 'A' listed item in a 'B' listed building, surrounded by a 'C' listed graveyard, we have the whole alphabet of problems!

In the meantime the various bodies who will be involved in a sale, the Council, the Trustees, Planning, Historic Scotland, Archaeologists, and the Law Office, have all been involved.

Perhaps you can imagine what I would love for Christmas!

If there are any of you out there who would like to buy the old Church, well, it will possibly not be up for sale until 2017, but do express an interest to me, or the Law Office of the Church of Scotland in Edinburgh.

In the meantime, I hope that all in the community have an enjoyable Christmas. Please remember that there is a reason for the Season – Jesus Christ came to earth to rescue us and save us – if we miss this or don't understand it, then we miss the point entirely.

Ricky



Merry Christmas & Good Health 2016

**Anderson Contracts (Ellon) Ltd
(Formerly Jim & Paul Anderson)**

Now offer “All Trades”

Professional decorating

Bathroom/Kitchen renovations

Windows and Door replacement

Private and Commercial

01358 722781

07872310862

“Old Newburgh-on-Ythan” by Janet Jones.



By the time this edition of the newsletter comes out, the book “Old Newburgh-on-Ythan” should be available in local shops and possibly from Amazon. It can also be ordered directly from the publisher by ringing 01290 551122 Mon. – Fri. 9am -5pm or email:

sales@stenlake.co.uk

The book costs £10 and there is no charge for postage and packing.

FOVERAN COMMUNITY COUNCIL MEMBERS 2016

Chairman:	William Grant, Bank House, Udney Station AB41 6QJ	01651 842791
Secretary:	Glen Douglas, 23 Eider Road, Newburgh, AB41 6FD	01358 789761
Treasurer:	Pauline Winslade 24 Eider Road, Newburgh, AB41 6FD	01358 788922
Kate Duncan,	Thistlyhill Steading, Udney Station, AB41 6QN 01651 843777	
Katrin Prager,	1 Hardhillock Cottages, Tillycorthie, Udney AB41 6SD	01651 842197
Pat Smith,	Newburgh	01358 789821
Tommy Hart,	5 Marshall Road, Newburgh. AB41 6DR	01358788971
Liz Hancock	Cultercullen	01651 842813
Youth Member:Emma Sleith	12 Mavis Bank, Newburgh, AB41 6FB	01358 789143
Youth member: Daniel Leask	The Old Mill of Fiddes, Udney	07738 166731

2015-2016

25 November	Newburgh Mathers
2016	
24 February	Foveran School
23 March	Newburgh Mathers
27 April	Udney Station
25 May	Foveran School
22 June	Newburgh Mathers
24 August	Udney Station
28 September	Newburgh Inn AGM then meeting at 20.15
26 October	Udney Station Hall
23 November	Newburgh Mathers



M. N. HAMILTON & SONS

Decorating Specialists For Over 35 Years

Internal & External Painting & Decorating to All Domestic,
Commercial & Industrial Premises

Paper Hanging • Ames Taping • Plastering • Specialist Finishes • Powerwashing

All General Joinery Repairs to Windows, Sills, Doors, Facings, Soffits & Fascias.

Timber Floors Sanded & Sealed and Industrial Floors Sealed & Painted.

All work carried out to the highest standards by Time Served Tradesmen.

MNH Power Access - Lorry Mounted & Power Access Platforms with Approved Operators



Tel 01224 637299

70 Ardarroch Road, Aberdeen AB24 5QS

